

Cahier Technique

Panneaux de porte d'entrée ALUMINIUM

Fichiers DXF ou DWG disponibles
sur simple demande

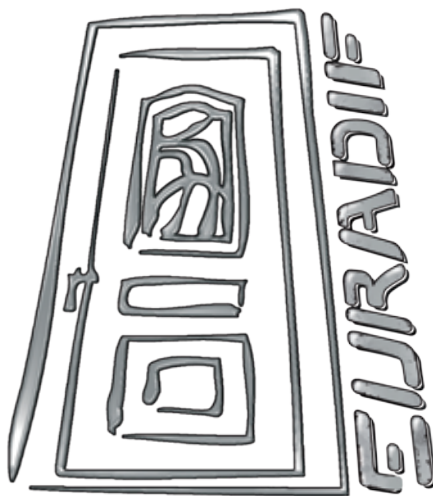

TOLERANCE :

Pour les panneaux de porte d'entrée ALUMINIUM

Toutes les côtes indiquées ont une tolérance pour la longueur et la largeur de ± 30 mm
pour l'épaisseur de ± 2 mm

LA COLLECTION «LES LUMIERES»

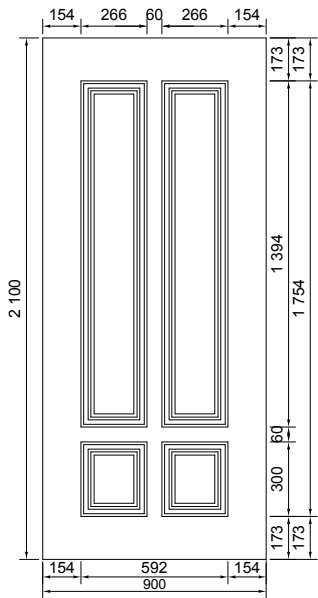

ALCOR

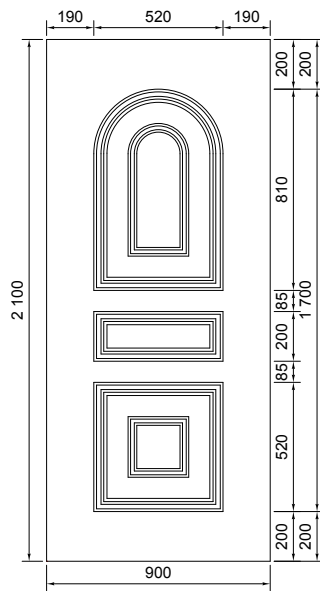

ANTARES

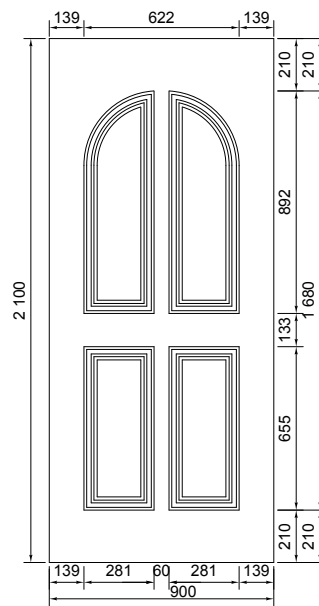

ATRIA

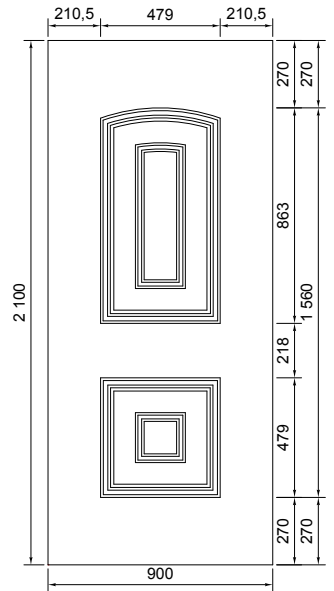

CAPELLA

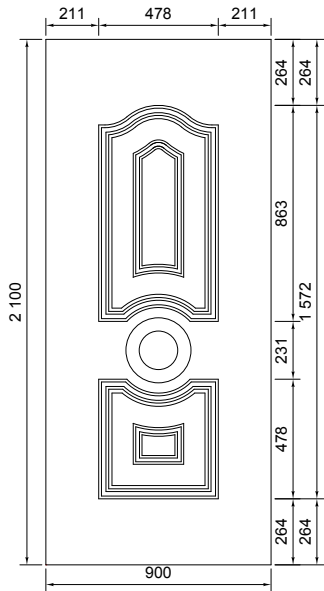

ELECTRA

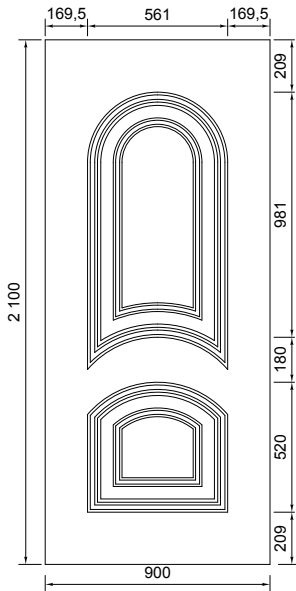

MAIA

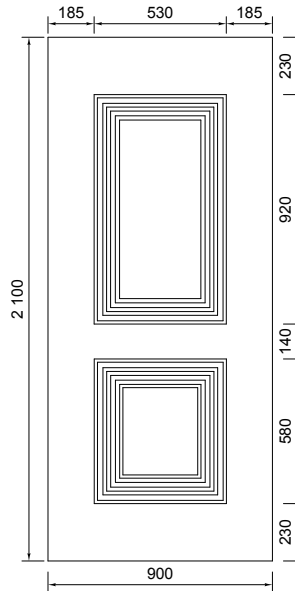

NAOS

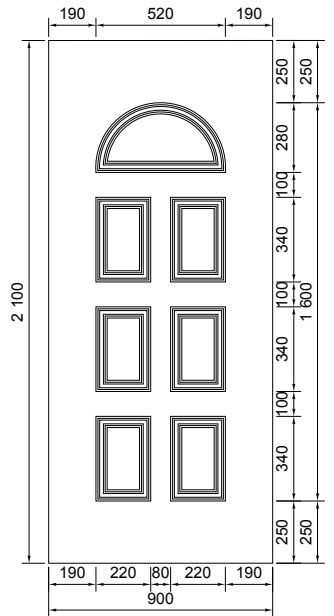

ORION

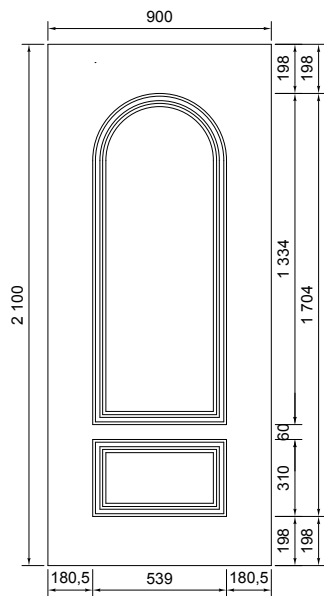

POLARIS

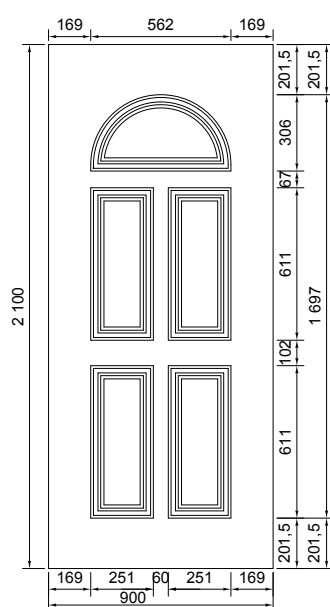

SIRIUS

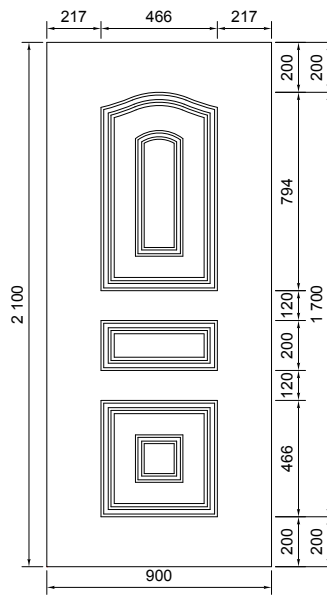

VEGA

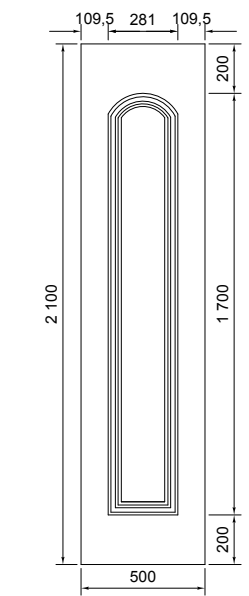

ZANIAH

LA COLLECTION «LES LUMIERES»

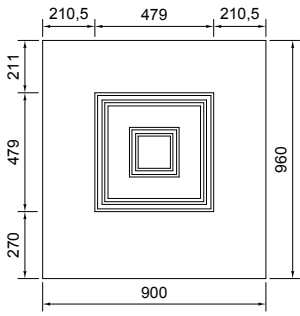

1/2 CAPELLA

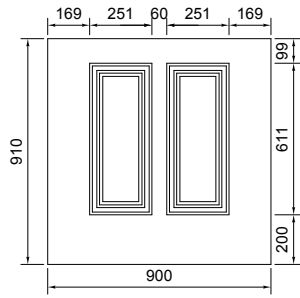

1/2 SIRIUS

LA COLLECTION «SEDUCTION»

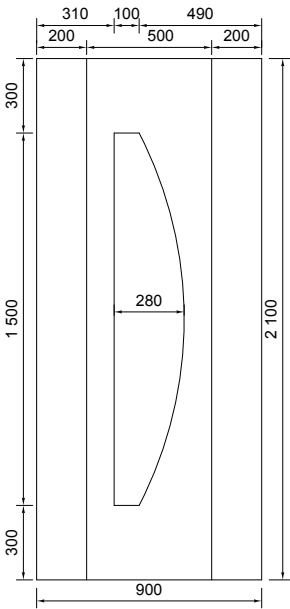

AGATE

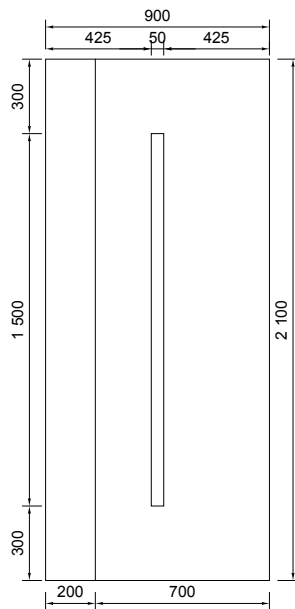

AMBRE

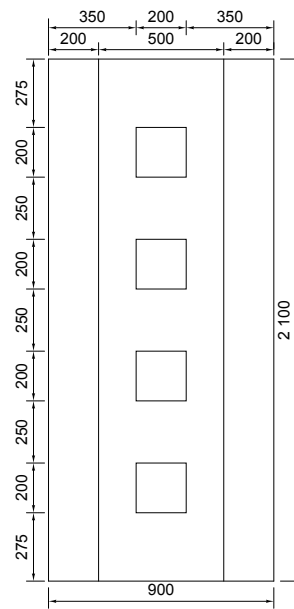

AMETHYSTE

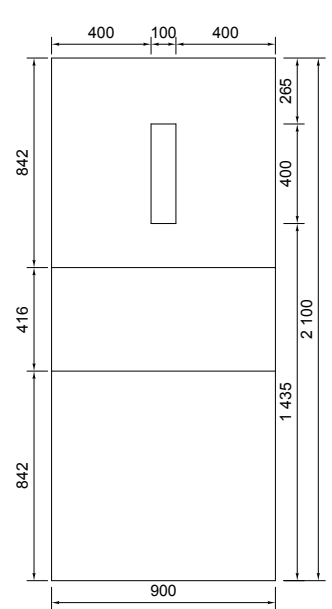

CITRINE

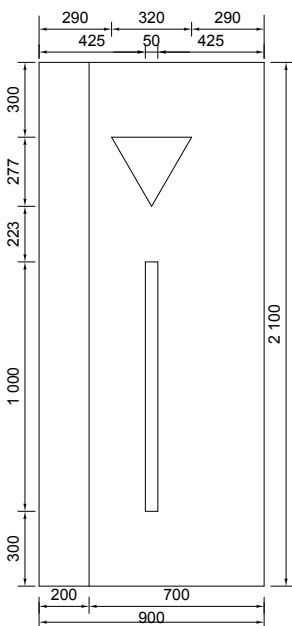

DIAMANT

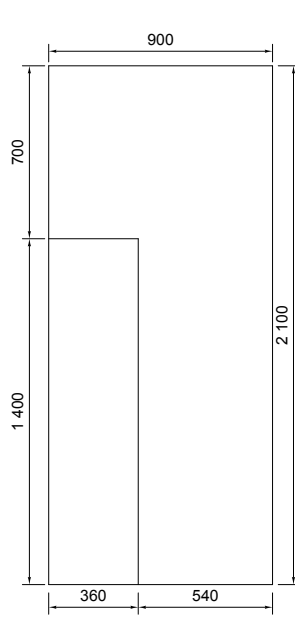

EMERAUDE

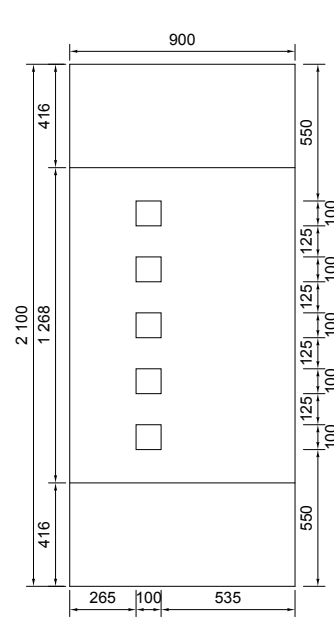

JADE

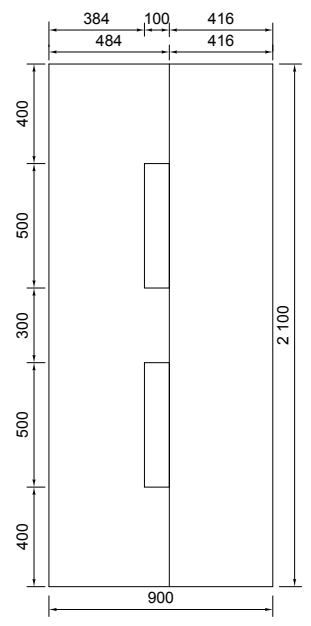

OPALE

LA COLLECTION «SEDUCTION»

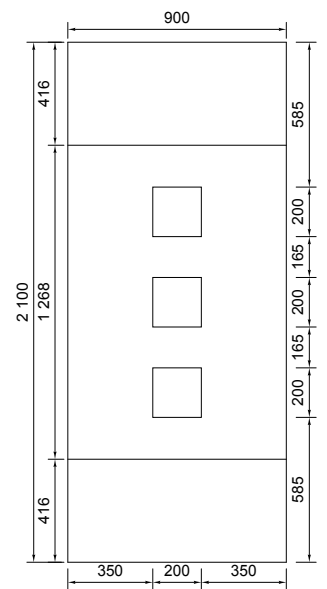
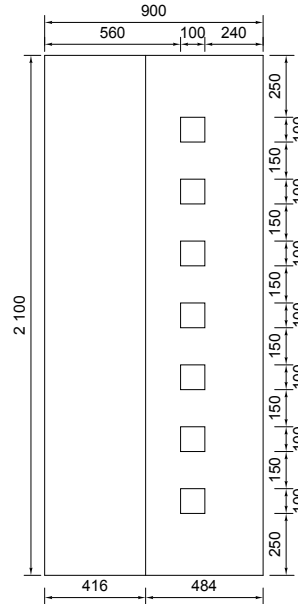
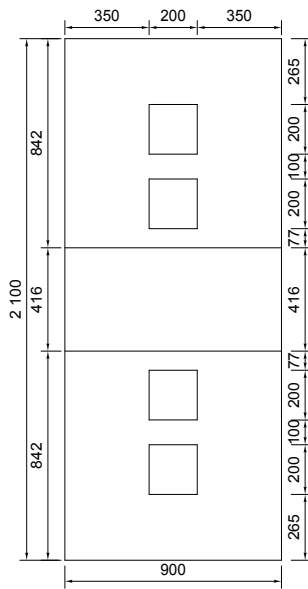
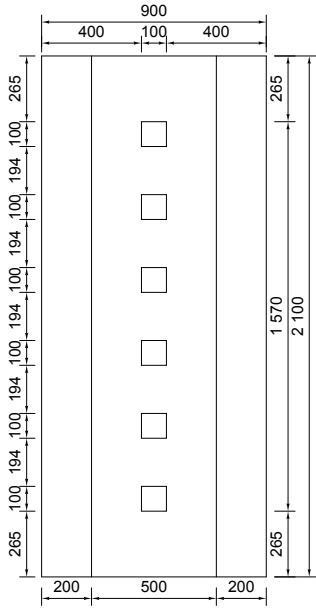

QUARTZ

RUBIS

SAPHIR

TANZANITE

LA COLLECTION «LES CONTEMPORAINS»

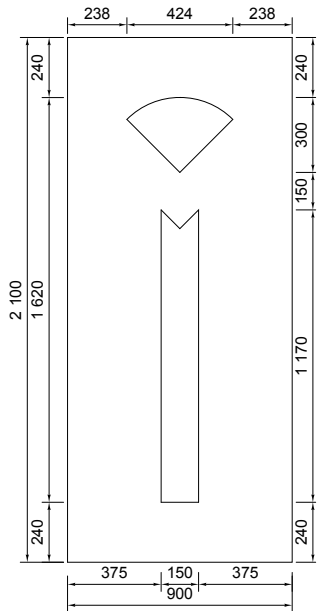
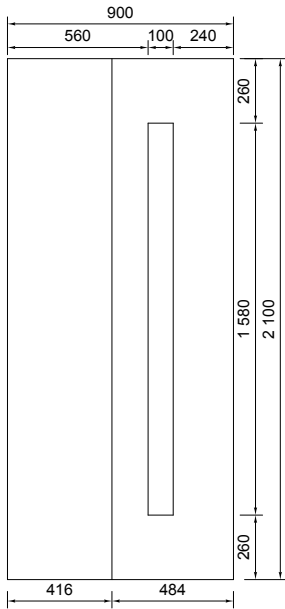

TOPAZE

AZUL 2

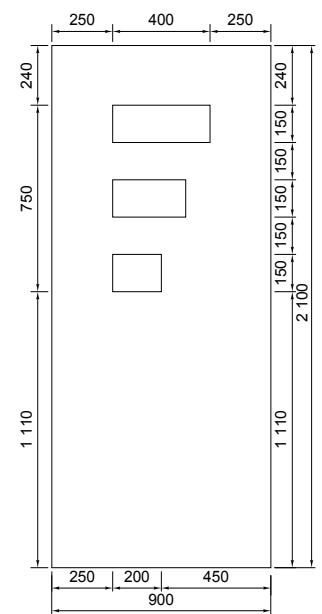
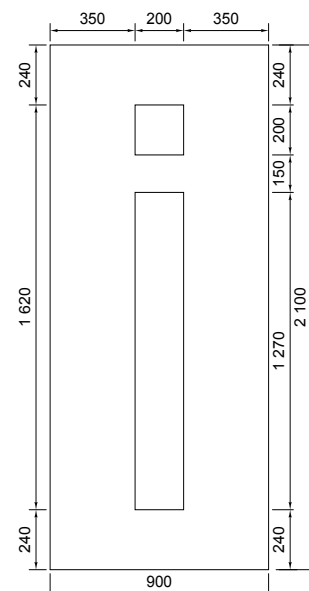
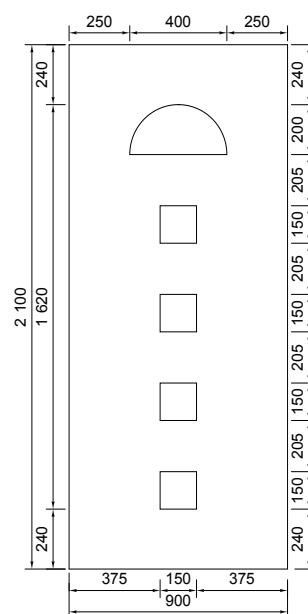
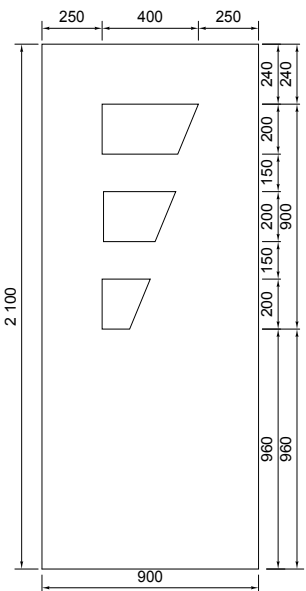

BOGOTA 3 GAUCHE

BUGA 5

CALI 2

COBAN 3 GAUCHE

LA COLLECTION «LES CONTEMPORAINS»

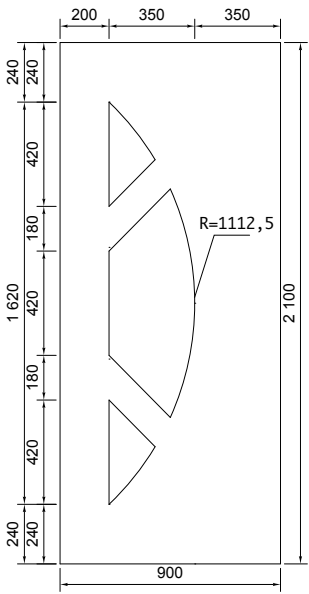

GOYA 3 Gauche

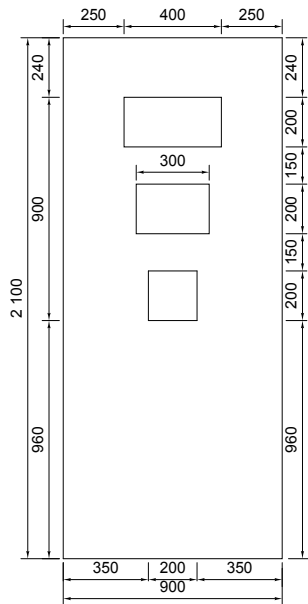

JUNIN 3

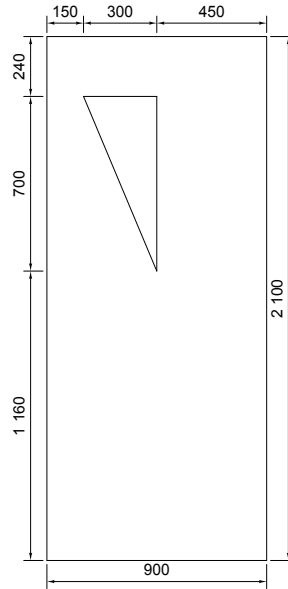

LA PAZ 1 GAUCHE

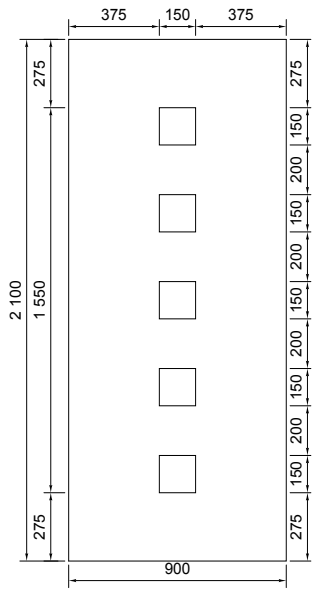

LIMA 5

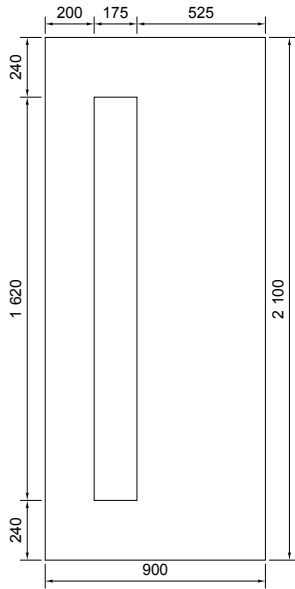

MEXICO 1 Gauche

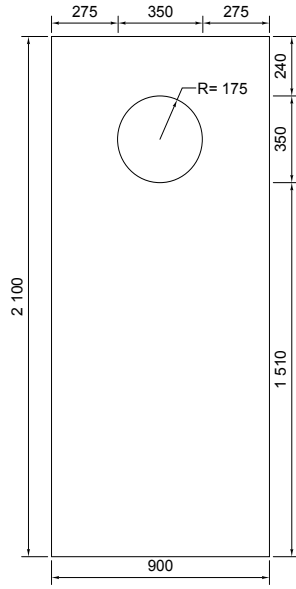

MINAS 1

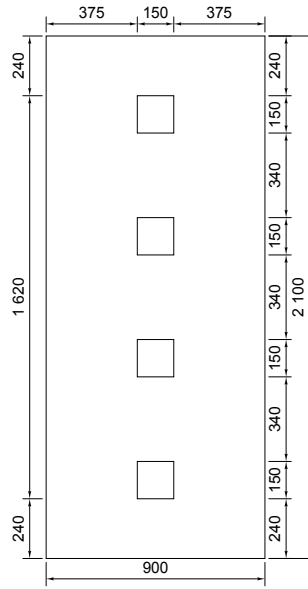

ORURO 4

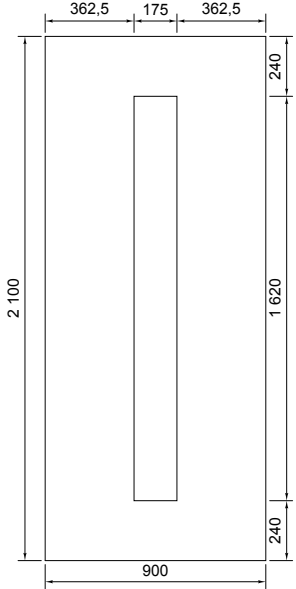

PASTO 1

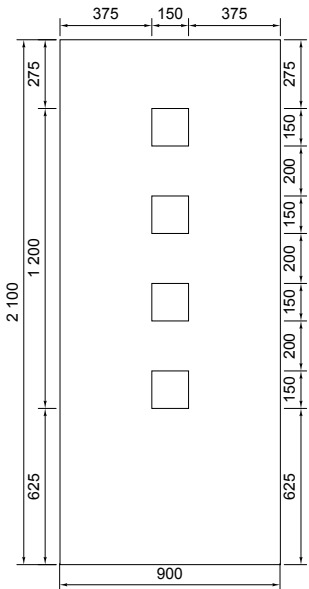

RIVERA 4

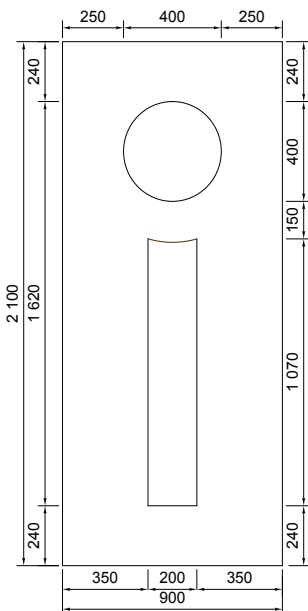

ROSARIO 2

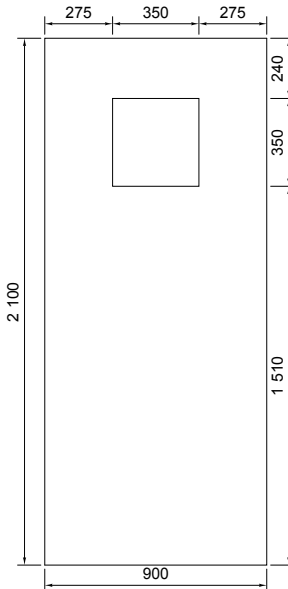

SALTA 1

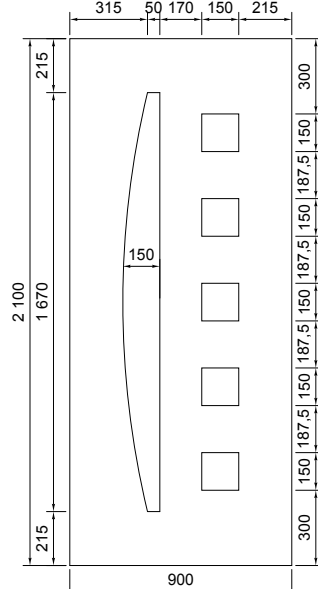

TRINIDAD 6

LA COLLECTION «SILLAGE»

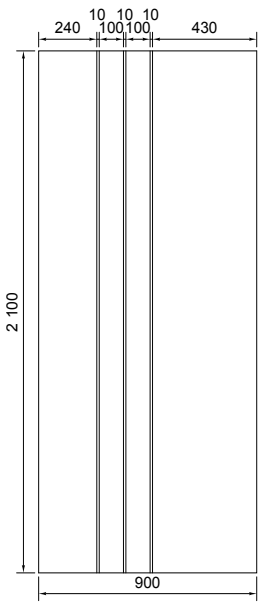

ACAJOU

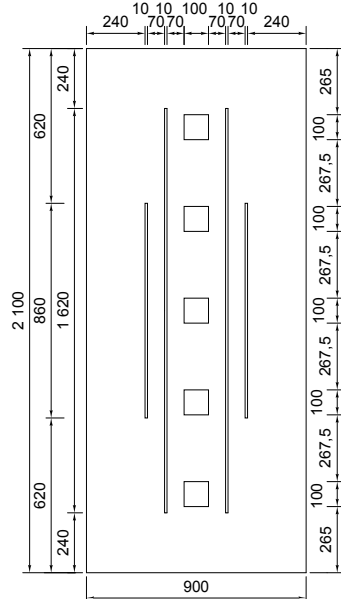

AMARANTE 5

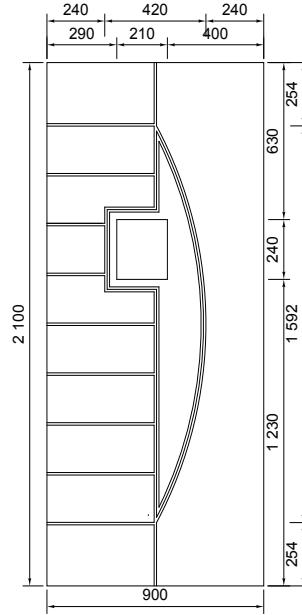

ANDROMEDE 1

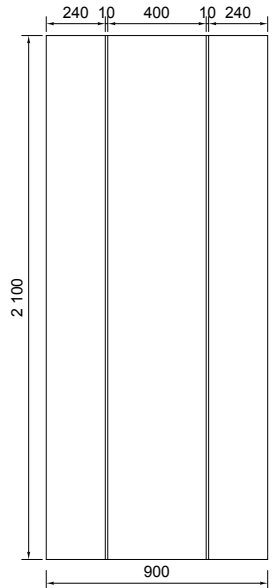

ARDOISE

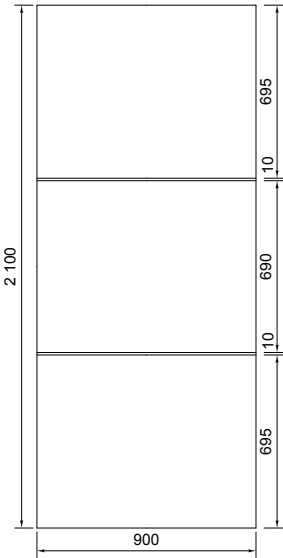

AUBERGINE

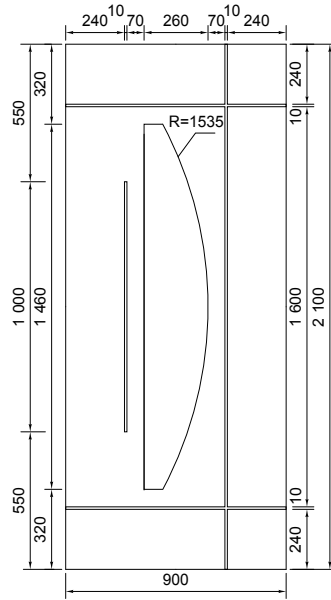

AUBURN 1

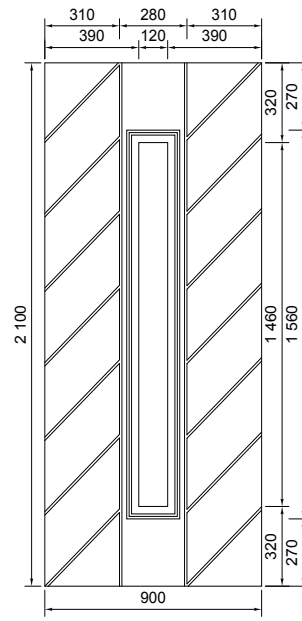

BOUVIER 1

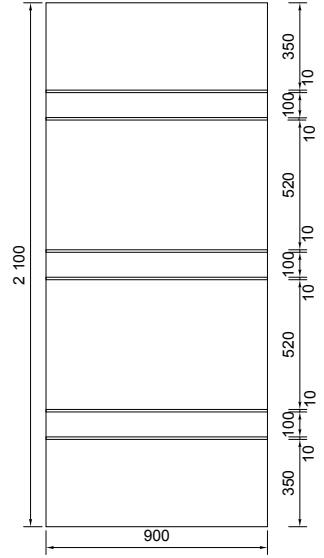

CARMIN

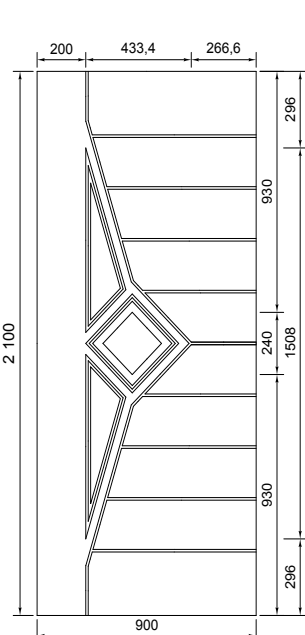

CASSIOPEE 1

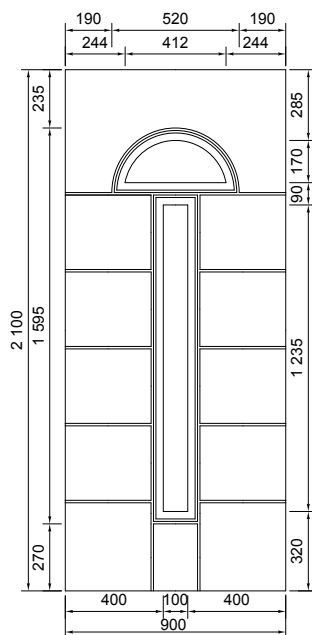

COCHER 2

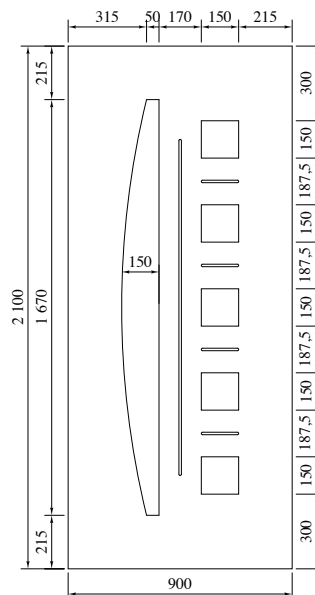

CORAIL 6

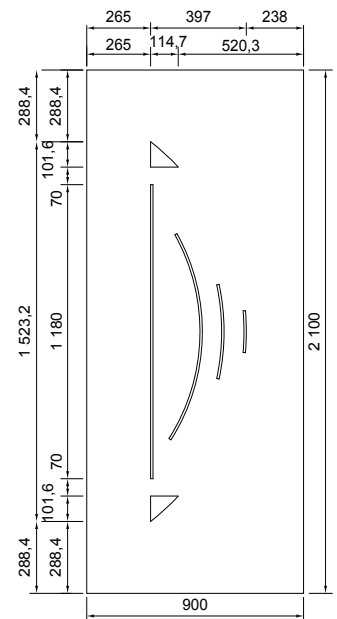

CYAN 2

LA COLLECTION «SILLAGE»

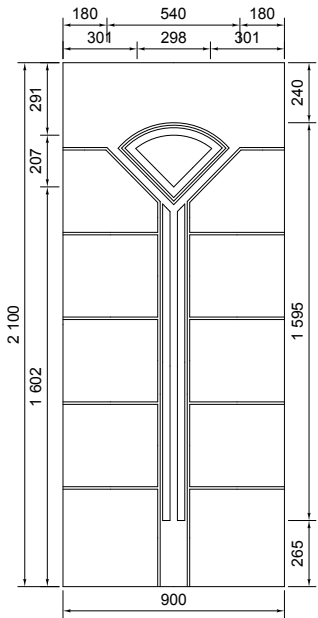

DRAGON 1

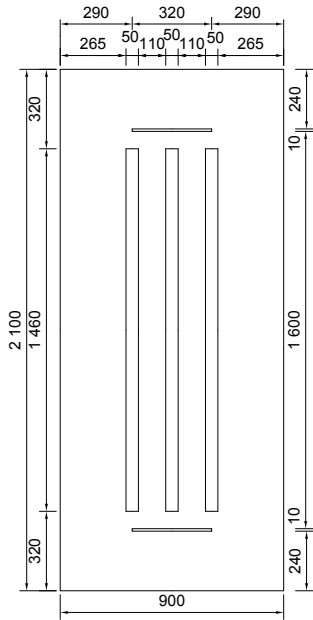

EBENE 3

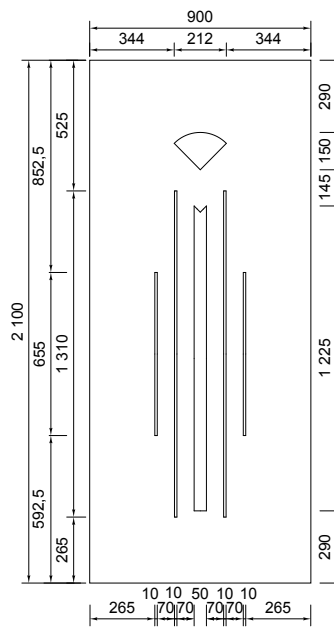

FUSHIA 2

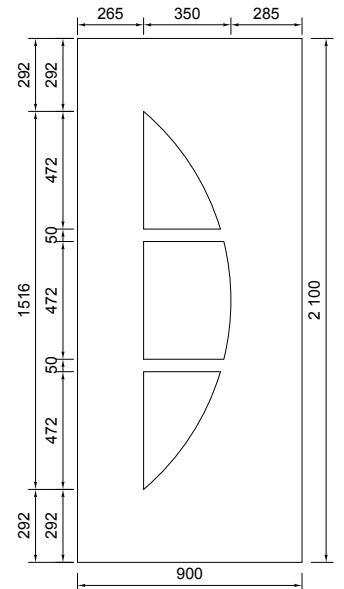

GARANCE 3

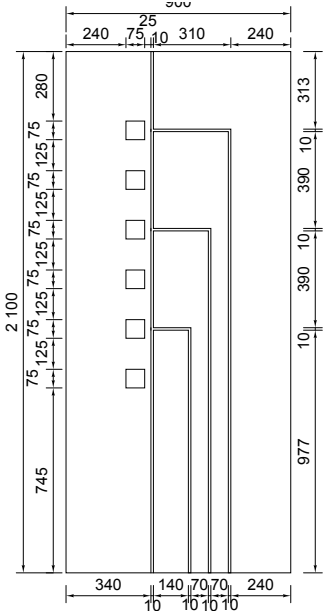

HAVANE 6

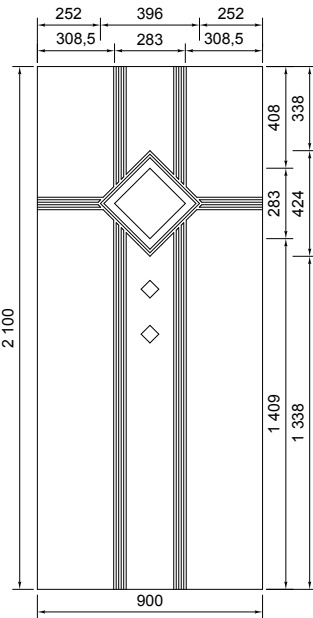

HERCULE 1

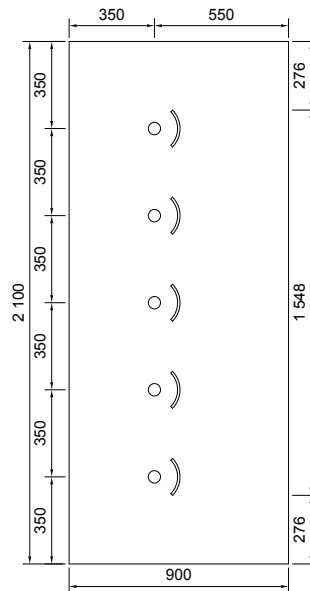

INDIGO 5

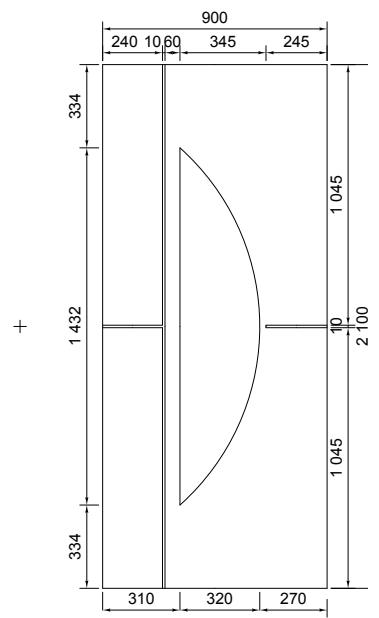

LAVANDE 1

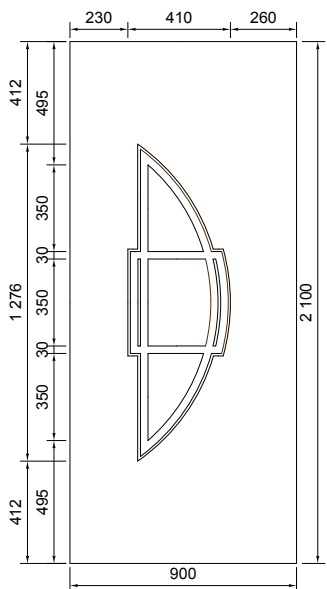

MAGENTA 3

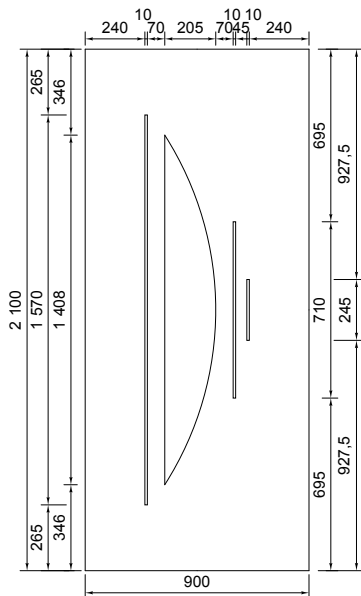

NACARAT 1

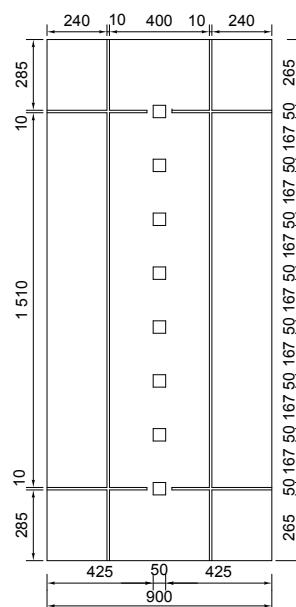

NACRE 8

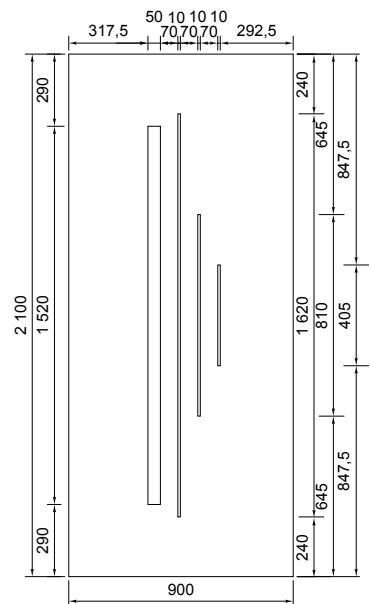

OCRE 1

LA COLLECTION «SILLAGE»

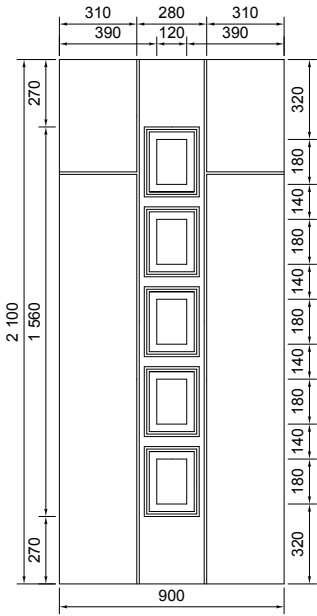

PEGASE 5

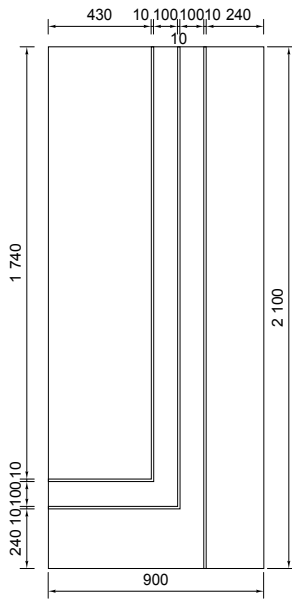

POURPRE

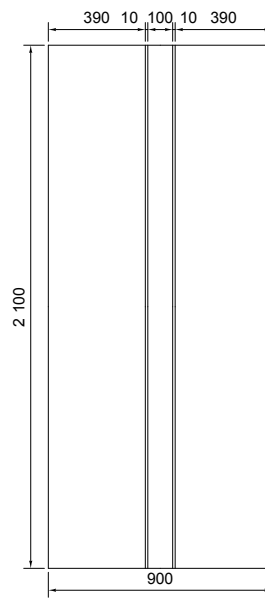

PRUNE

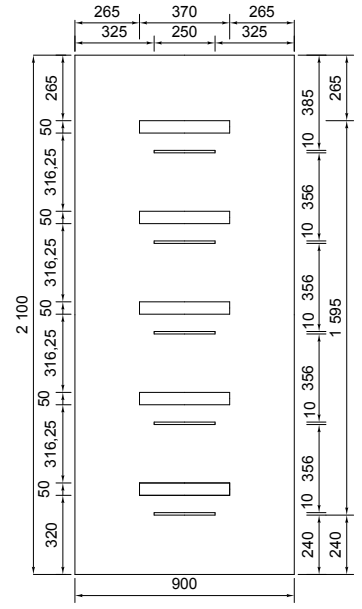

RESEDA 5

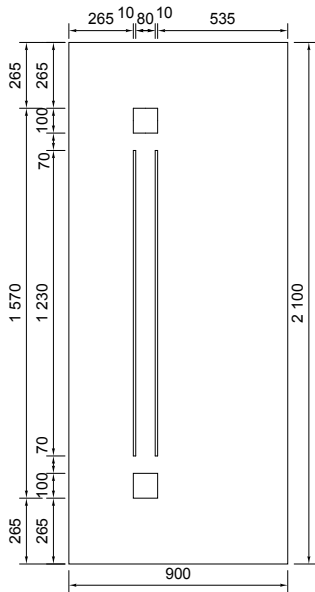

SEPIA 2

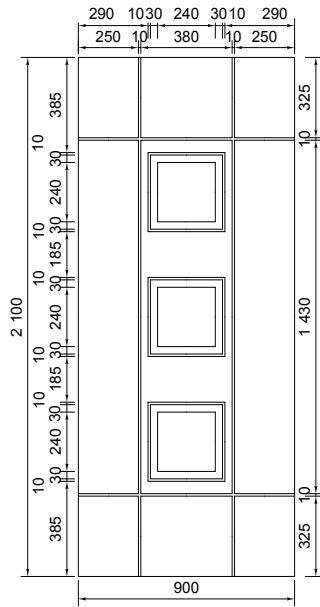

TURQUOISE 3

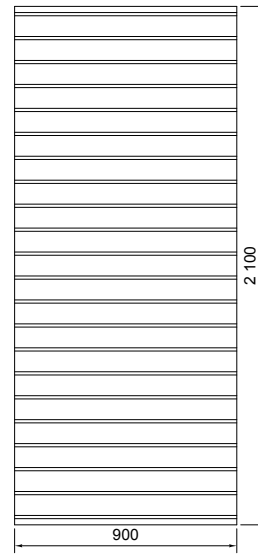

ANILINE

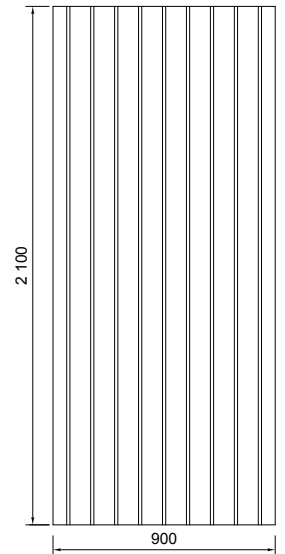

MAUVE

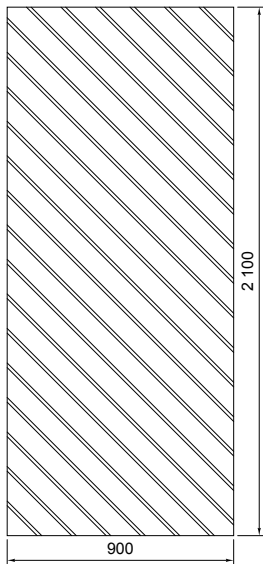

SAFRAN

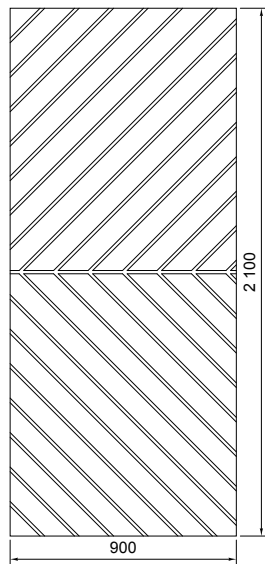

SINOPLÉ

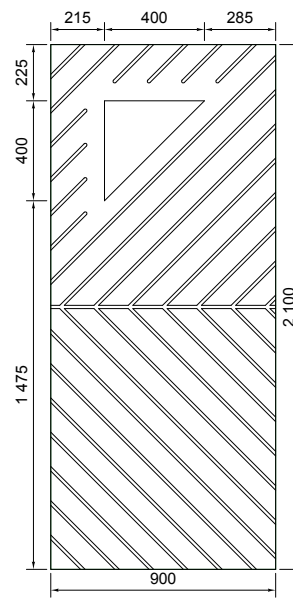

SINOPLÉ 1

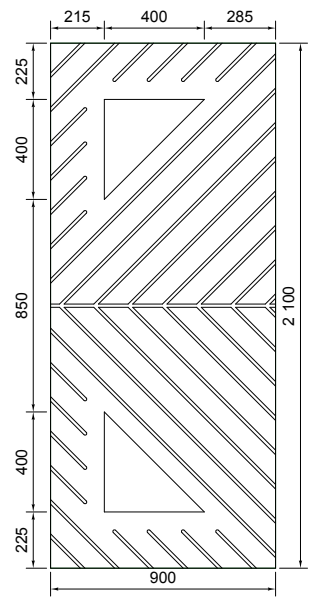

SINOPLÉ 2

LA COLLECTION «SILLAGE EVOLUTION»

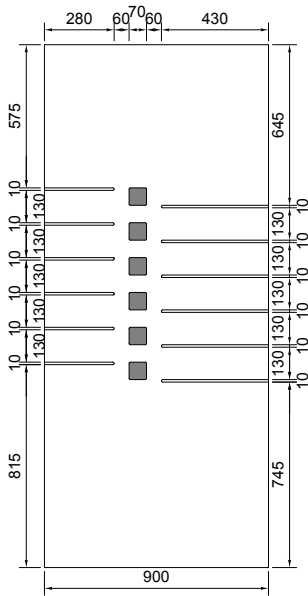

ABRICOT

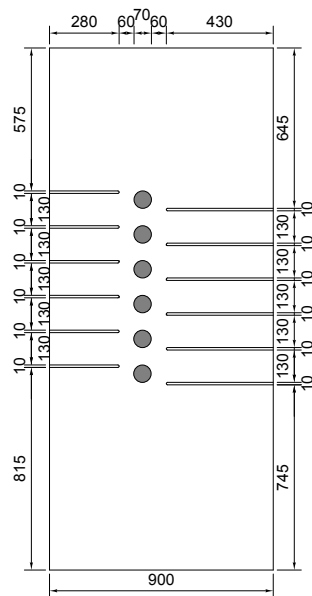

ABSINTHE

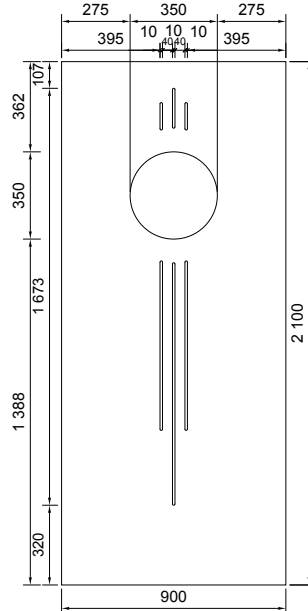

ANTHRACITE 1

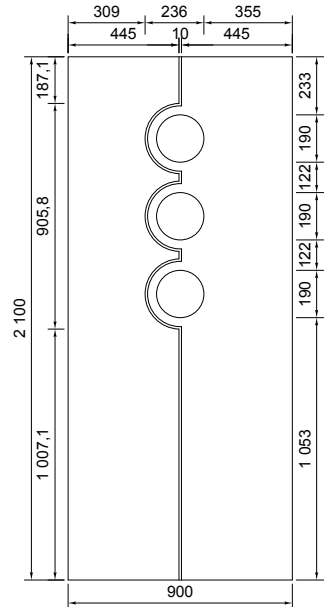

FAUVE 3

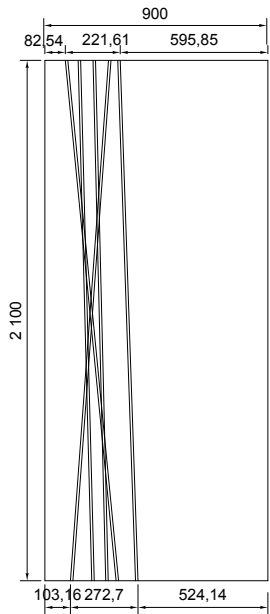

PARME

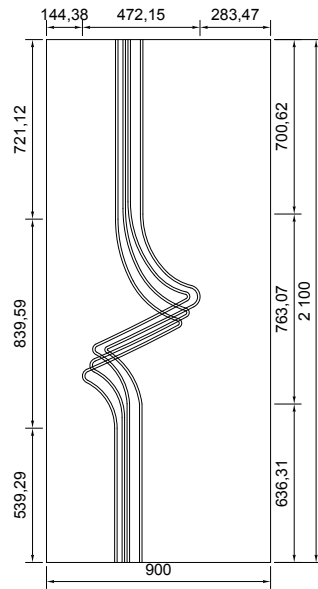

VERMEIL

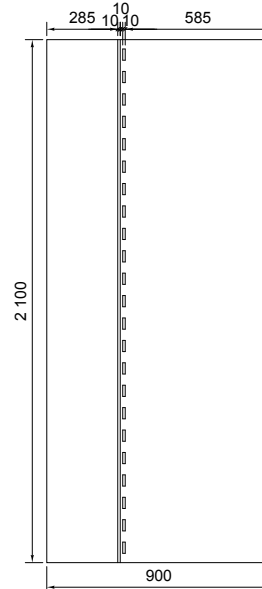

VIOLINE